

Article number: 208050331

Description: E+G Sphericalwasher male DIN 6319-37-C-NI
Stainless Steel 1.4305

Measures

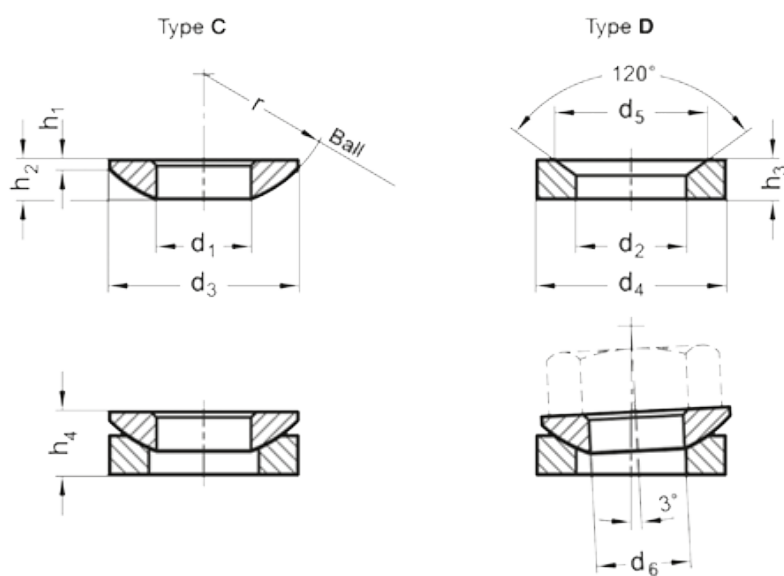

$d_1 = 37.0$

$d_3 = 68$

$d_6 = M36$

$H_1 = 4.6$

$H_2 = 14.0$

$H_4 = 23.5$

$r = 50$